



IIS4

IIS8

IWS4

**INDUCTION COOKING TOP FOR
RESIDENTIAL AND PROFESSIONAL USE**

INSTRUCTIONS
for installation and use

CAUTION

1. These safety directions apply to different kinds of appliances. Please identify correctly the specific appliance in your possession (check the tag showing the characteristics).
2. Before using the appliance, read the instruction manual carefully, as it contains important safety information on the proper installation, use and maintenance of the appliance. Please keep the instruction manual for further reference.
3. The appliance's electrical safety is guaranteed only if the electrical system is earthed in accordance with the relevant regulations. It is of the utmost importance to follow such regulations; when in doubt, please consult a qualified electrician to have the electrical system thoroughly checked. The manufacturer declines all responsibility for damage caused by a badly-earthed electrical system
4. Before connecting the appliance, make sure that the appliance's technical characteristics shown on the tag correspond to those of the electrical system and gas distribution network.
5. Make sure that the electrical system and sockets can handle the appliance's maximum power consumption as shown on the tag. When in doubt, please consult a qualified electrician.
6. The appliance should be connected to the electric supply line by means of an omnipolar switch with a minimum contact opening of 3 mm
7. If the power socket is not compatible with the plug, replace the socket with a proper one and consult a qualified electrician to make sure that the cable size can handle the appliance's maximum power consumption. The use of adapters, multiple power boards and extension cords is not recommended.
8. When not in use, switch off the general power supply to the appliance and close the gas supply valve.
9. Do not obstruct the appliance's cooling or heat dissipation vents.
10. In case of damage to the appliance's power cord, it must be replaced exclusively by the manufacturer's authorized service center.
11. The appliance must be used only for the purposes for which it has been expressly designed (cooking). All other uses (such as the heating of a room) are considered inappropriate and therefore dangerous. The manufacturer declines all responsibility for damage resulting from improper use of the appliance.
12. The use of any electric appliance implies the observance of some basic rules. More specifically:
 - A. Do not touch the appliance with wet or damp hands or feet;
 - B. Do not use the appliance with bare feet;
 - C. Avoid the use of extension cords and, if necessary, take all precautions;
 - D. Do not pull the power cord to disconnect the plug from the power socket;
 - E. Do not leave the appliance exposed to atmospheric agents (rain, sun, etc.);
 - F. Do not allow children or untrained persons to use the appliance.
13. Before cleaning the appliance or performing maintenance work, disconnect the appliance by pulling the plug out of the power socket or turning off the main switch.
14. In case of failure or malfunction, turn the appliance off, close the gas supply valve and do not attempt to carry out any repairs, which must be done exclusively by an authorized service center.

Request the use of original spare parts only. Failure to comply with the above recommendations may compromise the appliance's safety

FIG.A

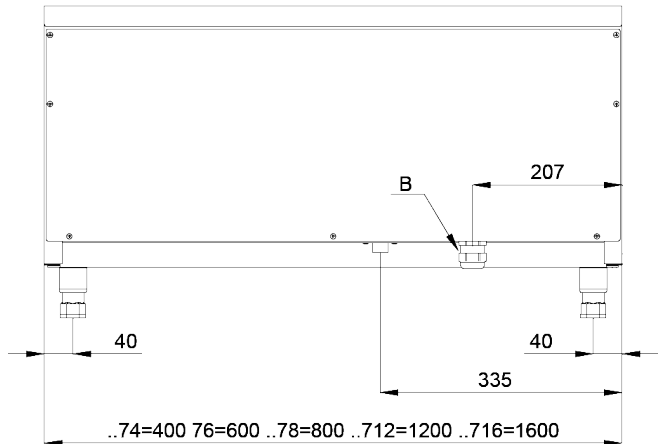
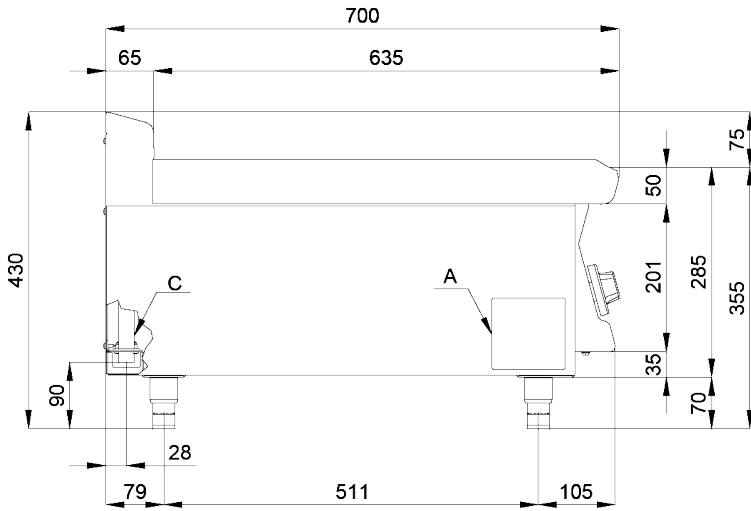

A. Data Plate

B. Electrical connection

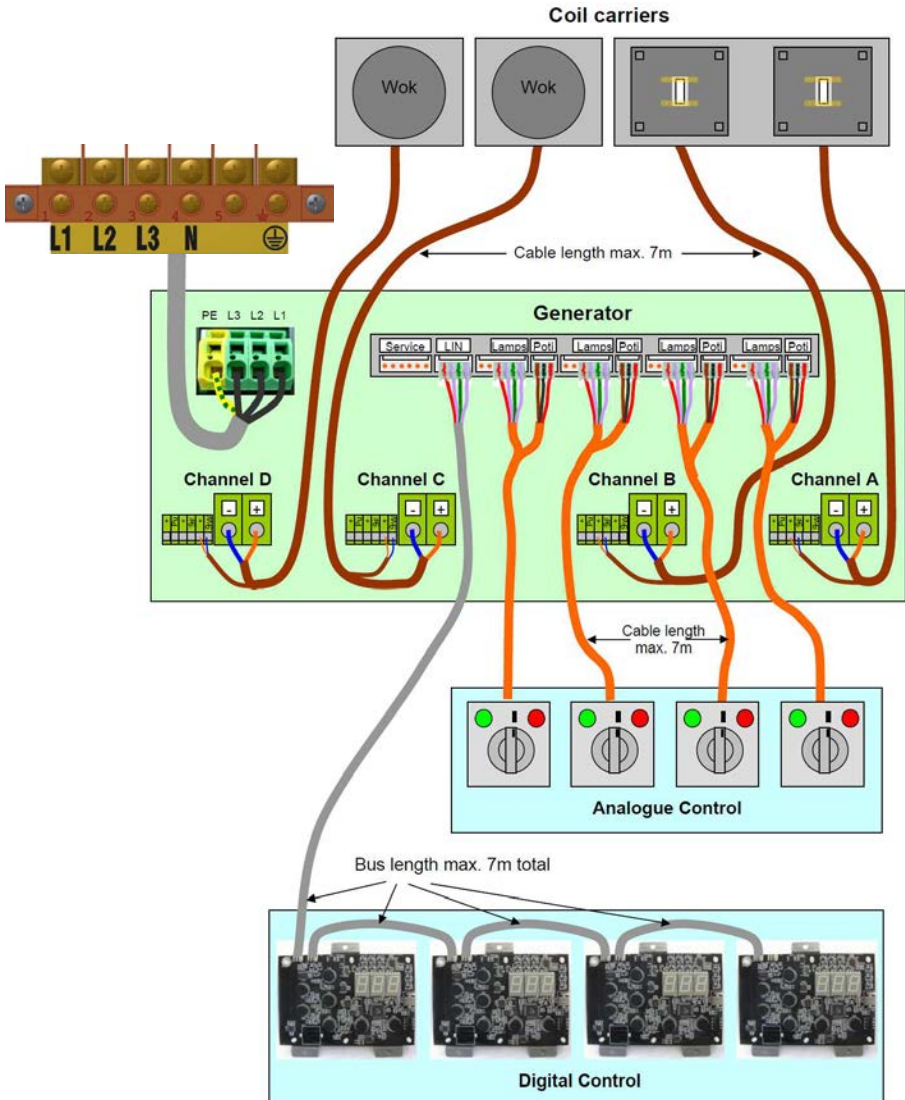
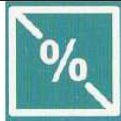
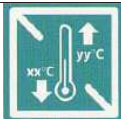

FIG.B
CONNECTIONS OVERVIEW



INDEX

GENERAL TECHNICAL DATA.....	8
TECHNICAL DATA TABLE.....	8
DECLARATION OF COMPLIANCE.....	9
INSTRUCTIONS FOR INSTALLATION.....	9
LAWS, TECHNICAL RULES AND NORMS.....	9
INSTALLATION	9
ELECTRIC CONNECTION.....	10
EQUIPOTENTIAL.....	10
INDUCTION GENERATOR.....	11
STARTING THE APPLIANCE.....	13
INSTRUCTIONS FOR USE.....	13
POTS AND PANS	14
FUNCTION CHECK.....	15
SWITCH OFF	15
FLEX TOUCH	16
NORMAL MODE	16
TOUCH KEY FUNCTION	16
POT DETECTION	17
PARAMETER LIST	17
RESIDUAL HEAT SYMBOL H.....	17
TROUBLESHOOTING	18
ERROR CODE PATTERN	19
FAULT MESSAGES FROM THE GENERATOR (E1).....	20
FAULT MESSAGES FROM THE DIGITAL CONTROLS (E2).....	21
CLEANING AND MAINTENANCE.....	22
PROCEDURE TO FOLLOW IF THE APPLIANCE IS NOT GOING TO BE USED FOR SOME TIME	23
MAINTENANCE (ONLY FOR QUALIFIED PERSONNEL)	23
ACCESSIBILITY	23
PROCEDURE TO FOLLOW IN THE EVENT OF A BREAKDOWN	23

GENERAL TECHNICAL DATA

	Minimal pan diameter:	120 mm
	Relative humidity:	10% to 90% non-condensing
	Operation Ambient temperature:	0°C ÷ 40°C
	Voltage tolerance: Supply frequency:	-10% ÷ +6% 50 – 60 Hz

TECHNICAL DATA TABLE

MODELS	DIMENSIONS cm	POWER SUPPLY	Power max kW	Absorbition max A	Power supply cable
IIS4	40 x 70 x 29h	400V/3 50/60 Hz	10	14,4	4 x 1,5 mm ²
IIS8	80 x 70 x 90h	400V/3 50/60 Hz	20	29	4 x 4 mm ²
IWS4	40 x 70 x 29h	400V/3 50/60 Hz	5	7,2	4 x 1,5 mm ²

LDECLARATION OF COMPLIANCE

The manufacturer declares that the appliances are compliant with the prescriptions of the EEC norm 90/396. The installation must be done observing the norms in force particularly concerning room ventilation and discharging gas emissions.

N.B.: The manufacturer declines any responsibility for direct or indirect damage caused by improper or incorrect installation, alterations, maintenance or use of the appliance, as in all the other cases considered in the items of our sales conditions.

INSTRUCTIONS FOR INSTALLATION

The data plate is on the side (see diagram in electric connection item) and has all the data necessary for the connection.

LAWS, TECHNICAL RULES AND NORMS

Installation must be carried out observing the following norms:

- Safety prescription in force
- Installation prescription in force.

INSTALLATION

When fitting, the appliance must be levelled using a spirit level; slight differences of level can be adjusted by screwing or unscrewing the adjustable feet. The main switch or the socket must be near the appliance and easily accessible. It is advisable to place the appliance under an extractor hood so that steam is extracted rapidly. If the appliance is placed near walls, dividing panels, kitchen furniture, decorative finishing, etc. , these should be in flameproof material; otherwise it is necessary to cover them with non-flammable material.

Above all, it is necessary to ensure that the fire prevention norms are observed.

Always comply with the following points during installation:

- Ensure that mains voltage complies with the voltage indicated on the specification table of the appliance
- All electrical installations must comply with local standards. All standards issued by national electrical authorities must be complied with.
- When circuit breakers are used, they must be suitable for a minimum of 30 mA.
- Avoid obstruction of air intakes or outlets with objects (fabric, walls, etc).
- Keep hot air off of the induction appliance (for example when several appliances are next to one another, or behind one another, or when an appliance is separated by a separate air duct.
- The induction appliance must not be placed near or on hot surfaces.
- The appliance is equipped with a filter. Regardless of this filter, make sure that grease from other activities do not get onto the induction appliance (for example from nearby fryers or hot plates).
- The temperature of input air must be less than +35°C.
- Personnel that use the appliance must ensure that installation, maintenance and checks are carried out only by qualified staff.

Attention! In accordance with international rules, when connecting the appliance, an automatic device enabling the disconnection of all contacts from the mains, must be installed above it; this device must have a contacts opening of at least 3 mm..

ELECTRIC CONNECTION

The appliance is supplied without the connection cable. To install the power supply cable, proceed as follows:

- Disconnect the power supply.
- Remove the bottom panel
- Push the connection cable through the cable blocker, connect the conductor wires to the corresponding terminals in the junction box and fix them into place.
- Block the cable with the cable blocker, and reassemble the bottom panel. The earth wire must be longer than the others so that if the cable blocker should break, it will disconnect after the tension wires.

N.B. The connection cable must have the following characteristics: it must be at least the silicone type (resistant to a temperature of at least 180°), and must have an adequate section for the power of the appliance (see technical data table).

EQUIPOTENTIAL

The appliance must be connected to an equipotential system. The connection screw is positioned at the back of the appliance and is identified by the symbol .

Attention:

The manufacturer will neither be held responsible for, nor will give any compensation during the guarantee period for any damage caused, and which is due to inadequate installations not compliant with the instructions.

Indication:

- each plate is connected to a power adjuster which lets you choose from minimum temperature, indicated on the knob by the number 1, and the maximum temperature, indicated by 6. For initial cooking the highest temperatures are advised.
- each plate is equipped with a temperature limiter which activates when the current temperature may damage the glass (see the paragraph "what to do in case of problems").

Warning: use only suitable pans (with ferrite bottom e.g. steel 430).

INDUCTION GENERATOR

INDUCTION GENERATORS ARE A COMPONENT AND ARE NOT A COMPLETE, FINISHED MACHINE.

Fields of use.

Induction generators can be installed in fitted hobs and free-standing cookers and should be used for cooking, heating, keeping things warm and roasting.

All the specific saucepans recommended for use for induction cooking can be used with induction generators, such as saucepans in cast iron and chrome-plated iron, as well as enamelled pans. They should have a diameter of between 16 and 26 cm.

Induction generators should not be used to heat objects other than those listed above.

Caution! Hazard!

CAUTION

Incorrect usage and failure to comply with the instructions provided could cause injury or damage to people and property.

CAUTION

Before using or carrying out maintenance work on the appliance, please read this use, maintenance and installation manual carefully.

HAZARD

Failure to follow the relative safety regulations, laws and directives could expose you to hazard.

HAZARD

The incorrect use or handling of the generators poses a hazard to people, animals and property. Failure to read and study this use and installation manual exposes you to hazard.

Personnel qualification and training.

The personnel responsible for installing, commission, using and maintaining the appliance must be **QUALIFIED** or **AUTHORISED** by the manufacturer.

Hazards caused by failure to observe the safety regulations.

Failure to observe the safety regulations can pose a hazard to people, the surrounding environment and the induction generator itself. Failure to observe the safety regulations causes the guarantee to become null and void, meaning that you will no longer be entitled to replacements for damaged parts.

In particular, failure to observe the regulations entails:

- risks of all kinds to people and property.
- hazards of all kinds to people and property.

Safe usage.

It is important to observe the safety regulations in the manual, and the relative national and international laws and regulations regarding electrical safety, national and international laws

and regulations regarding safety in the workplace, and national and international laws and regulations on accident prevention.

Safety of the user or personnel responsible for use.

Electrical hazards should be excluded. The induction generator should be used by qualified personnel and it should be installed by a certified professional in compliance with specific international, national and regional regulations on electrical and electronic appliances for collective use and civil and industrial electrical installations.

Safety of the personnel responsible for use.

The pyroceram area is heated by the heat of the saucepan. To avoid burns, do not touch the heating zone.

To avoid excessive overheating, do not leave the empty saucepan on the heat or heat it for no reason.

If cooking with several saucepans at the same time, make sure that the handles do not cross each other and that they are outside the field of induction. The handles may become very hot depending on the type of material from which they are made.

Risk of burns! We recommend using oven gloves.

Saucepans must always be kept a small distance apart. They should not touch each other. When you remove the saucepan, it is advisable to switch off the cooking zone to prevent the heating system from switching back on automatically should you happen to replace the saucepan.

Do not place other material (paper, card, fabric, etc.) between the saucepan and the cooking zone as it could catch fire.

Metal objects heat up very quickly if placed in the heating zone when it is in operation. It is therefore advisable not to place objects other than saucepans on the induction hob (cans, closed tins, aluminium trays, cutlery, rings, keys, watches, etc.)

People with pace makers should consult their doctor to find out whether they can work in the vicinity of a hob with induction generator.

Do not place credit cards, phone cards, cassette tapes or other magnetic objects on the pyroceram plate with induction system.

The induction generator has an internal cooling system. Make sure that the air inlet and outlet holes are not blocked by objects (paper, rags or other). This could cause overheating and lead the induction generator to switch itself off.

Do not allow liquids (water, oil or other) to enter the induction generator.

Do not clean the generator with a jet of water.

If the pyroceram top is cracked or broken, switch off the induction hob and disconnect the electricity supply. Do not touch any of the internal parts of the induction generator.

Safety during installation, maintenance and controls.

The personnel responsible for use must be qualified. All installation, maintenance and control operations must be performed by personnel qualified to issue the relative certificates requested by the relative authorities as regards safety in the workplace.

Said personnel must study this manual in depth. Only highly qualified personnel may install, maintain, service, repair and collect the induction generator component. In practice, said personnel must be trained by means of a specific training course authorised by the manufacturer as regards the induction generator.

Moreover, they must meet the requirements set by the relative authorities as regards the electrical and electronic safety of installations. Generally speaking, work should only be carried out on the induction generator component after it has been disconnected from the electricity supply.

The induction generator must be switched off and disconnected from the power supply and electricity network.

The safety and protection installations must be replaced and reinstalled at the end of the above operations, in keeping with the international, national and regional regulations and laws on safety, thus ensuring correct and safe usage of the component.

Reproduction or use of unauthorised spare parts.

Reproductions or changes to the induction generator component are not permitted. Contact the manufacturer if you observe any changes to the induction generator. To ensure safety, always use original spare parts, authorised by the manufacturer.

The manufacturer declines all responsibility in the event in which non-original spare parts have been used.

Improper usage.

The good working order of the induction generator components is only guaranteed in the event of correct usage as described in this manual and as regulated by the international, national and regional laws and regulations on safety and electromagnetic compatibility, which regulate components such as the induction generator.

STARTING THE APPLIANCE

Before using the appliance for the first cooking, it is necessary to clean it carefully, (see paragraph “cleaning and care”).

Check the connection of the appliance and start it up following the instructions.

INSTRUCTIONS FOR USE

Caution:

- Always keep an eye on the appliance while it is in use!
- For models IIS we recommend using flat-based pans, since those with a concave or rounded base increase the cooking times and use more energy.

Instructions:

- each plate is connected to a power adjuster which lets you choose between the minimum temperature, indicated on the knob by the number 1, and the maximum temperature, indicated by 6. For initial cooking the highest temperatures are advised.
- each plate is equipped with a temperature limit switched which is triggered when the temperature reached may damage the glass (see the paragraph "what to do in case of problems").

Warning: only use suitable pans (with a ferrite base, i.e.430 steel).

What is induction cooking?

The principle of induction cooking is very simple. When the pan is placed on the pyroceram surface of the hob, it enters a magnetic field generated by an induction system. The ferrous base of the pan heats up rapidly as molecules rub against one another, producing heat. The heating speed and intensity can be adjusted by controlling the magnetic field.

Why should you choose induction ?

For Safety, because there are no flames or heat sources that create hazards when the pan is removed from the heat source. The hob shuts off automatically as soon as the pan is removed
For Speed, because heat is generated directly inside the pan, allowing it to heat up immediately.
For the same reason, the temperature is adjusted immediately, in the same way as gas cooking
For Efficiency, because compared with other types of cooking, induction has very high energy yield, around 85%. This cooking system also keeps the surrounding area cool and healthy, as there is no heat dispersion, unlike other types of cooking appliances.

POTS AND PANS

Induction generators only work properly with saucepans with an iron, cast iron or chrome-plated iron base. These pans may also be enamelled.

The generators accept all the above type of saucepans and adapt in real time to supply the same power.

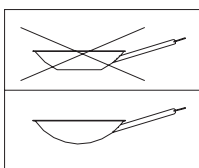

IIS The pans must have a diameter of between 160 mm and 260 mm.

It is best for the pans to have a flat base.

IWS For Wok machines, the pans must have a concavity that adapts to the glass standard 311 Ø mm. (see Photo)

The generator does not accept unsuitable pans.

Any other product no mentioned in this paragraph should be considered automatically excluded and unsuitable for use with induction generators.

FUNCTION CHECK

After everything is connected perform the function check.

- Remove pot from the cooking zone.
- Adjust the cooking level to zero.
- Switch on the mains supply.
- The green and the red lamp must not light or blink.
- The display must only show the cooking level 0.
- Increase the cooking level to any number.
- Green lamp must blink every second regularly (pot detecting mode).



- On the display pot detection symbol  must blink (pot detecting mode).
- No fault must occur.
- Red lamp must not light / No error code on the display.
- Place on cooking zone a water filled induction pot which has a minimum of 12 cm Ø.
- Green lamp or display must continuously be on.



- Adjust to maximum power.
- After a few minutes the fan must switch on.



**Do not heat empty pans without supervision.
Always place pans in the centre of an inductor zone. Pans should not
be heated up to more than 300° C.**

If an error occurs, refer to next section on troubleshooting.

SWITCH OFF

- Turn the knob/potentiometer in a clockwise or anticlockwise direction until it is in the rest position [OFF]
- Certain parts of the generator are still powered even when the cooker is switched off. Therefore, if carrying out maintenance work, disconnect the appliance from the power supply first.
- Make sure that no liquid penetrates the induction generator, either during normal use or during cleaning and maintenance of the component.

FLEX TOUCH

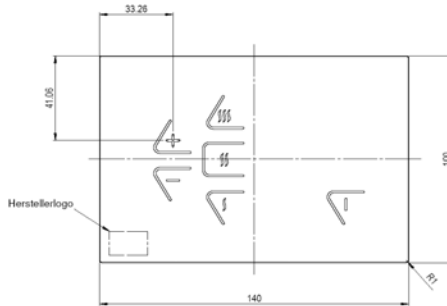

NORMAL MODE

The touch key allocation is standardised as pictured below.

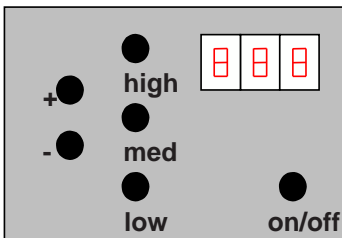

TOUCH KEY FUNCTION

On/off key:

The on/off key switches the FlexTouch on and off. On the 3 digit display appears 0 if the FlexTouch is on.

After switching it on and no key is pressed for a long time the FlexTouch switches automatically off. The display switches off.

+ key:

The + key enables the cooking level to be gradually increased. The current cooking level appears on the display.

- key:

The - key enables the cooking level to be gradually decreased. The current cooking level appears on the display.

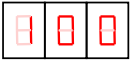
**high-key:**

The max key enables the pre-programmed maximal cooking level to be reached. This has a standard configuration set at 100.

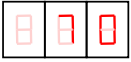
**med-key:**

The medium key enables a pre-programmed middle cooking level to be reached. This has a standard configuration set at 70.

**low-key:**

The min key enables a pre-programmed minimal cooking level to be reached. This has a standard configuration set at 40.

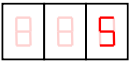
POT DETECTION

When no pot is on the cooking zone, the display changes between the pan symbol and the preset cooking level.

PARAMETER LIST

Description	Adjustment range	Default value
Preset cooking level high	1 – 100	100
Preset cooking level medium	1 – 100	70
Preset cooking level low	1 – 100	40

RESIDUAL HEAT SYMBOL H

The H symbol appears when the glass ceramic temperature exceeds 65°C. The cooking surface should not be touched as there is a risk of burning. The symbol will light when the appliance is off. However, in the event of power failure it will not light.

TROUBLESHOOTING

- CAUTION: NEVER carry out any work on the induction generators without first having disconnected them from the power supply .
- HAZARD: high voltage present in induction generators powered by the electricity supply .
- The induction generators should only be opened by QUALIFIED, AUTHORISED PERSONNEL IN COMPLIANCE WITH INTERNATIONAL, NATIONAL AND REGIONAL SAFETY LAWS AND REGULATIONS.

Fault	Cause	Corrective action
Insufficient heating of cooking zone	Unsuitable pan material	Use suitable pan material
Continuous heating of cooking zone at maximum power	Knob switch faulty	Check / replace knob switch
Empty cooking zone starts operating	Pan detection sensor faulty	Replace generator / have it repaired
Small metal objects are heated	Pan detection sensor faulty	Replace generator / have it repaired
No heating of cooking zone	Pan bottom Ø less than 12 cm	Use suitable pan material
	Generator defective	Replace generator / have it repaired
No reaction of appliance	Mains fuse / main supply interrupted	Check mains connection
Fuses blow when switching on	Short-circuit in generator	Replace generator / have it repaired

ERROR CODE PATTERN

There are two different error types:

- Generator errors (E1)
- Digital control errors(E2)

Generator errors are faults detected by the generator and forwarded to the control. On the display of the digital control “E1” appears. On the analogue controls faults can be detected according to the duration and frequency of the green light blinking. The green lamp lights one time long and than short regular flashes.

The number of these short flashes is the error number. This pattern is constantly repeated.

For example: error code E1 06 from the generator:

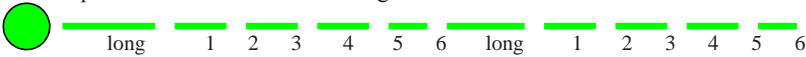

The red fault lamp remains on as long as an error exists.



Digital control errors are faults from the digital controls. On the display appears “E2” and than the error number.

FAULT MESSAGES FROM THE GENERATOR (E1)

Error.	No.	Name	Cause	Corrective action
E1	01	Hardware over current	Unsuitable pan material	Use suitable pan material
			Wrong or defective coil	Check the coil
E1	02	No inductor current	Inductor connection failure	Connect the inductor properly
E1	03	IGBT temperature too high	Air routes blocked Fan clogged, temperature sensor of IGBT defective	Clear air routes Clean fan, check fan rotation
E1	04	Cooking zone temperature too high or too low	Pan empty	Remove pan, switch off and wait a couple of minutes until the cooking field has cooled down
			Temperature sensor faulty	The sensor must be replaced
			Power board faulty	Replace the generator
E1	05	Control unit failure	Control unit defective or wiring defective	Check or replace operating unit, check wiring harness to unit
			Digital control has faulty ID	Switch the generator off, adjust the DIP-switches correctly
			Control unit faulty	Replace the control unit
E1	06	Internal temperature too high	Air routes blocked Fan clogged, temperature sensor defect, close exterior heat sources	Clear air routes Clean fan
E1	07	Coil temperature	Coil temperature to high	Remove pan, switch off and wait a couple of minutes until the cooking field has cooled down
			Temperature sensor faulty	The sensor must be replaced
E1	08	Mains phase failure	Breakdown of mains phase or mains quality insufficient	Check mains supply
E1	10	Communication error	Failure on LIN or CAN-Bus, no connection between keyboard and generator	Disconnect from mains and check connection
E1	11	Initialisation error	Needless control unit connected	Connect control unit to the correct control plug
			Digital control has faulty ID	Switch the generator off, adjust the DIP-switches correctly
			Failure while initialising of the hardware	Just wait, the device will be reset approx. every 30 sec.
E1	13	Mains connection error	Mains voltage is too high or too low	Check mains connection
E1	14	Mains adaptor error	Mains voltage is too high or too low	Check mains connection
E1	15	Empty pan protection	Mains error	Switch off the main fuse, wait a few seconds and switch on
			Empty pan	Remove pan, switch off and wait for a couple of minutes until the cooking field has cooled down
			Defective temperature sensor of the coil	The sensor must be replaced

FAULT MESSAGES FROM THE DIGITAL CONTROLS (E2)

Error	No.	Name	Cause	Corrective action
E2	03	Key pad permanently on	Water or cookware on the control glass	Clean control area
			Key button defect	Replace digital control unit
E2	05	LIN Bus opened	No detection of communication	Check LIN Bus
E2	10	Wiring interruption	Faulty connection between key pad and generator	Replace connecting cable
		Faulty ID	Digital control has a faulty ID	Switch the generator off, adjust the DIP-switches correctly
E2	11	Self diagnosis error	Self diagnosis of Software located error	Switch the power off and on, if the error remains contact customer support
E2	13	Invalid configuration data	The device found no valid configuration data	Contact customer support.
E2	14	Supply voltage	Problem with supply voltage of the key pad	Automatic reset
E2	20	Compatibility of LIN version	LIN version is not compatible	Contact customer support
E2	FF	Unknown error	An error occurred, its cause is unknown	Contact customer support.

CLEANING AND MAINTENANCE

Caution: During cleaning, do not wash the external parts of the appliance with direct or high pressure water jets.

Every evening, after use, clean the appliance thoroughly. Daily cleaning after switching off the appliance ensures the perfect functioning and long life of the appliance.

Before starting to clean the appliance, disconnect the power supply. The steel parts must be washed with hot water and neutral detergent, then rinsed thoroughly in order to eliminate all traces of detergent. They should then be dried with a dry cloth. Do not use abrasive or corrosive detergents.

Cleaning the glass

The glass should be washed with vinegar or lemon-based degreasers, suitable for cleaning ceramics and glass.

During this operation, it is best for the glass not to be completely cold, so that spilt food, burnt fat and other substances can be softened with a damp cloth and removed whilst still warm with a scraper, so as to prevent the glass surface from deteriorating.

Do not use abrasive or corrosive detergents.

Important: As well as ordinary cleaning and maintenance, it is advisable to have the installation checked by an installer at least once a year. It is therefore suggested to draw up an after-sales assistance contract.

CLEANING BURNISHED BRASS SURFACES

No synthetic protective varnishes have been used to obtain the special burnishing effect on the burnished brass details in order to avoid spoiling the beauty of the brass with an artificial patina. The antique finish of the surface is the result of natural oxidation that has simply been accelerated. All the natural antique finish brass surfaces can be cleaned with any kitchen degreasing detergent, accompanied by the use of an abrasive scouring pad (the green colored type used for washing dishes). It is recommended that the metal be rubbed, uniformly applying light pressure, until the desired effect is achieved.

The brass details should then be dried.

Do not use polish as this is suitable for maintaining the gloss but not the antique finish and could result in an effect that is not compliant with our products. Any spots that may appear over time on the burnished brass surfaces should be considered as a desirable and particular characteristic of our craft metal working processes.

CLEANING CHROMIUM-PLATED BRASS SURFACES

No synthetic varnishes have been used to obtain the special polish on the chromium-plated brass details in order to avoid spoiling the beauty of the chromium plating with an artificial patina. All the chromium-plated surfaces should be cleaned, where necessary, with a soft, possibly micro-fiber cloth, combined with metal polishing products, if required. Do not use abrasive pads.

CLEANING SATIN FINISH NICKEL-PLATED BRASS SURFACES

No synthetic varnishes have been used to obtain the special nickel-plating on the satin finish nickel-plated brass details in order to avoid spoiling the beauty of the nickel-plated, satin finished solid brass with an artificial patina. All the nickel-plated and satin finished brass surfaces should be cleaned, where necessary, with a soft, possibly micro-fiber cloth, combined with a neutral detergent, if required. Do not use abrasive pads.

CLEANING THE VARNISHED SURFACES

All the varnished surfaces should be cleaned using a neutral detergent and, where necessary, a soft, possibly micro-fiber cloth. Do not use abrasive pads or any other chemical products.

CLEANING BRUSHED STEEL SURFACES

All the brushed steel surfaces should be cleaned using degreasing products or products specifically designed to be used on steel and, where necessary, extra-fine steel wool or extra-thin sandpaper.

PROCEDURE TO FOLLOW IF THE APPLIANCE IS NOT GOING TO BE USED FOR SOME TIME

Clean and dry the appliance carefully according to the instructions. Disconnect the power supply.

MAINTENANCE (ONLY FOR QUALIFIED PERSONNEL)

Any kind of maintenance must only be done by qualified personnel. Before carrying out maintenance, remove the plug or switch off the switch above the appliance.

ACCESSIBILITY

To get to the junction-box, remove the front panel of the appliance. The control elements are reached from the front control panel; unscrew the fixing screws from the control panel and remove it.

PROCEDURE TO FOLLOW IN THE EVENT OF A BREAKDOWN

In the event of breakdown, turn off the appliance, disconnect the power supply by using the device situated above the appliance and notify the after sales service.



en
INTERNATIONAL
V 2.4 - 10.17

OFFICINE GULLO S.R.L.: via della Torricella 29, 50012 Antella - Bagno a Ripoli (FI)

Tel. +39 055 6560324 / 621807 - Fax + 39 055 620670 - info@officinegullo.com

WWW.OFFICINEGULLO.COM